

Strohballen-Figuren



Straw-bale figures
Figurines en bottes de paille
Stro balen-figuren

Art. Nr. 180560

- D**
- Vor Beginn des Bastelns sollten Sie sich mit den Spritzlingen und der Anleitung vertraut machen.
 - Sollte es einmal vorkommen, dass ein Teil im Bausatz fehlt, kreuzen Sie bitte das fehlende Teil in der Anleitung an und schicken Sie diese bitte an Fa. Gebr. FALLER GmbH, Abt. Kundendienst, Kreuzstraße 9, 78148 Gütenbach. Sie erhalten dann umgehend Ersatz.
 - **In diesem Bausatz sind einige Kunststoffteile übrig.**
- GB**
- Before commencing with the assembly please familiarize yourself with the parts and read the instructions carefully.
 - In case of missing parts please indicate these on the instructions leaflet with a circle and return the leaflet to Gebr. FALLER GmbH, Kreuzstraße 9, D-78148 Gütenbach, Germany. You will receive the replacement by return.
 - **Some of the parts in this box are not needed to construct the model.**
- F**
- Avant de commencer le montage de votre maquette bien lire la notice et repérer les grappes.
 - Si une pièce manquait dans une boîte, cochez la pièce correspondante sur la notice et renvoyez la nous à Gebr. FALLER GmbH, Kreuzstraße 9, D-78148 Gütenbach (R.F.A.). Nous vous ferons parvenir la pièce par retour.
 - **Dans cette boîte se trouvent quelques pièces qui ne seront pas utilisées pour le montage.**
- NL**
- Vóór het bouwen zou men de gietstukken en de handleiding moeten bestuderen.
 - Indien onverhoopt een onderdeel aan het bouwpakket ontbreekt, gelieve men het ontbrekende deel in de handleiding aan te kruisen en deze te zenden aan Gebr. FALLER GmbH, Kreuzstraße 9, D-78148 Gütenbach. U ontvangt dan omgaand en gratis het ontbrekende onderdeel.
 - **Van dit bouwpakket worden enkele kunststof delen niet gebruikt.**



170492
FALLER-EXPERT

Flüssigkleber in Plastikflasche mit Spezialkanüle für feinste Klebstoffdosierung.

FALLER-EXPERT

Liquid cement in plastic bottle with canule for very fine dosage.

FALLER-EXPERT

Colle liquide en bouteille plastique avec bec verseur pour un dosage précis.

FALLER-EXPERT

Vloeibare lijm in plastic-flacon met doseerbuisje om nauwkeurig te lijmen.



170688
Spezial-Seitenschneider

zum gratfreien Abtrennen von feinsten Spritzteilen. Nur für Polystyrol geeignet.

Special side cutter

for cutting off ultra-fine moulded parts without burrs. Only suitable for polystyrene.

Pince coupante spéciale

pour couper sans bavure les pièces miniatures moulées par injection. Uniquement appropriée pour le polystyrène.

Speciale zijknijptang

voor het braamloos afknippen van de fijnste gietstukdelen. Alleen geschikt voor polystyrol.



Inhalt	Spritzlinge	9A	1 x
Contents	Sprues	41B	2 x
Contenu	Moulages	43B	1 x
Inhoud	Gietstukken	43B	1 x

Sa. Nr. 221 266 0

2

41/2

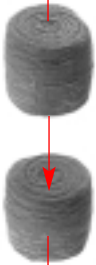

41/2

(A)

41/2



(A)

(B)

Deco 3

(B)

Deco 2

Deco 15

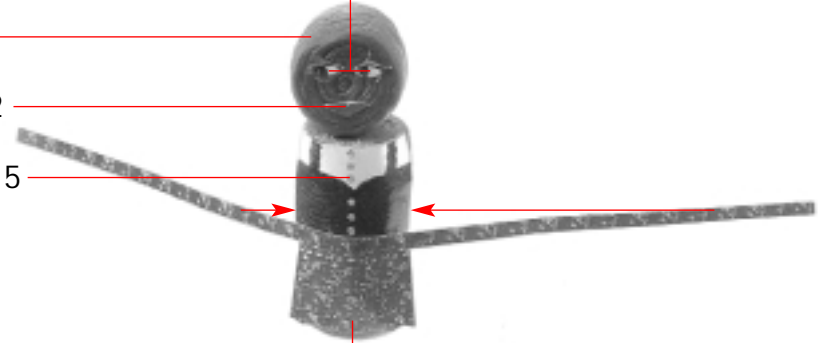

Deco 1

(C)

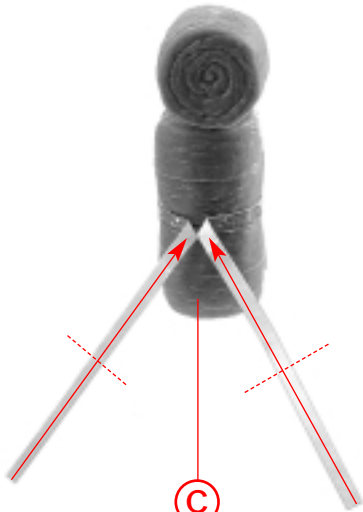

(C)

(D)



(D)

(E)



(E)

(F)

Faden, ca. 0,5 m
Cord
Aiguillée
Garen

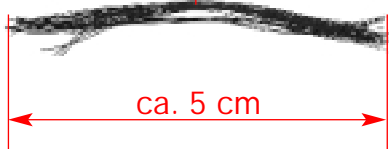

ca. 5 cm

G

G

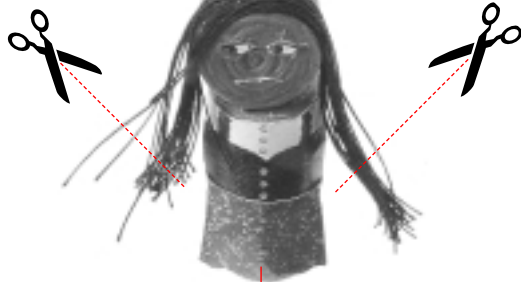

H

F

Deco 6

3

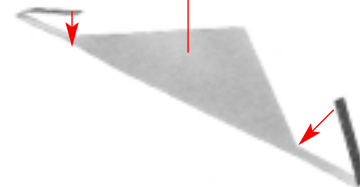

I

I

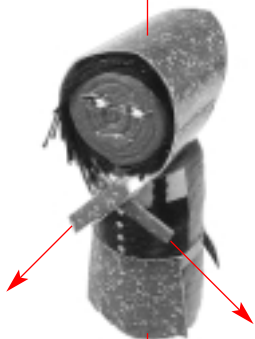

J

H



K

J

43/22

41/3 41/3
43/23 43/23

L

K

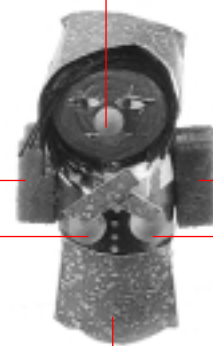

4

41/2

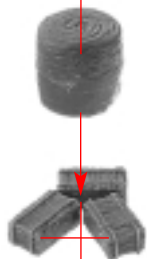

(M)

3 x 41/3

41/2

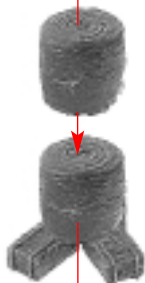

(N)

(M)

41/2

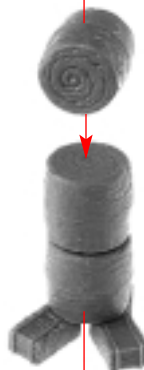

(O)

(N)

Deco 4

Deco 5

Deco 13

Deco 14



(P)

(O)

Faden, ca. 1,5 m
Cord
Aiguillée
Garen

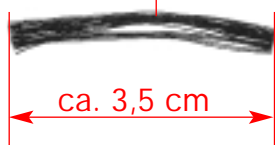

(Q)

(O)



(R)

(P)



(S)

(R)

43/22

41/3

41/3

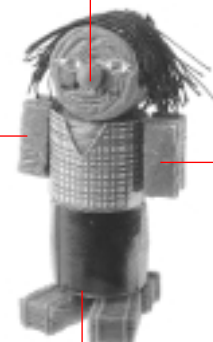

(T)

(S)

41/2

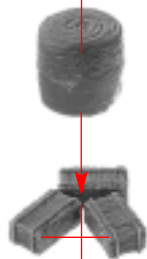

3 x 41/3

U

41/2

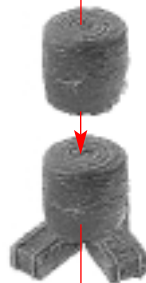

U

V

41/2

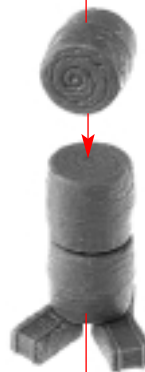

V

W

Deco 4

5



Deco 5

Deco 17

W

X

Deco 8

Löcher durchstechen
Pierce holes through
Piquez les trous
Gaten doorstéken

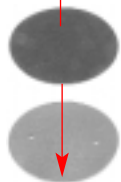

43/31

Y



Z

Y

Deco 10

43/30

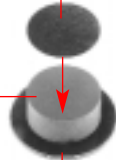

Z

a

Deco 9



a

b

43/22

b

41/3

Deco 7

41/3

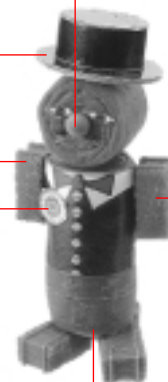

X

c

6

41/2



d 41/2

41/2



e **d**

Deco 3

Deco 2

Deco 16



f **e**

Faden, ca. 1,5 m
Cord
Aiguillée
Garen

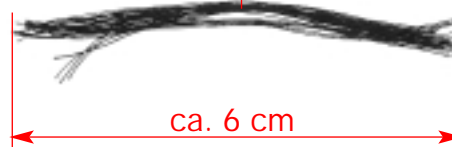

g

Klebestreifen
Adhesive tape
Ruban adhésif
Plakband



g

h



h

i

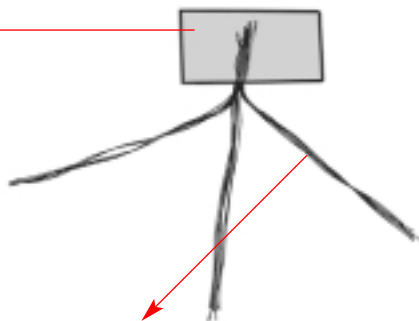

i

j

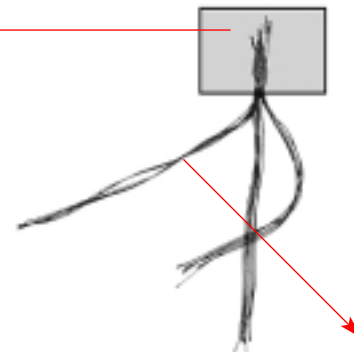

j

k

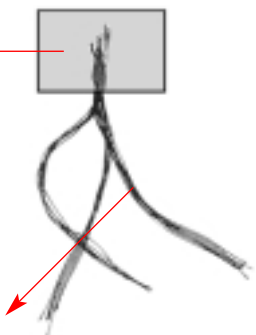

k

l

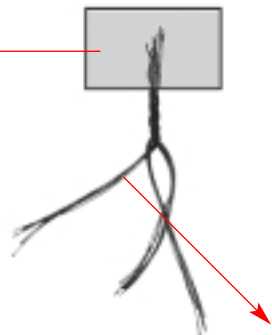

l

m

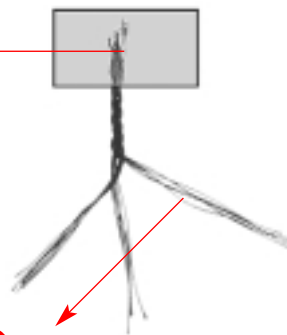

m

n

Faden verknoten und den Knoten
mit Sekundenkleber fixieren !
Knot the thread and fix the thread
with instand cement !
Noier le fil et renforcer le noed
avec une goutte de colle rapide !
Draad vastknopen en de knoop
met secondenlijm fixeren !



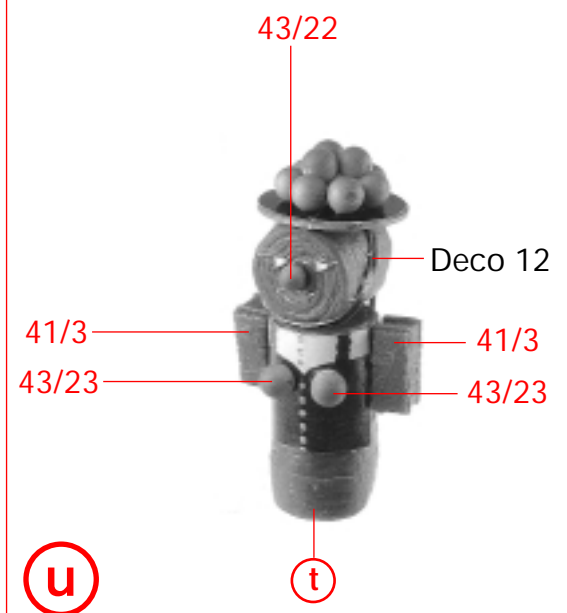
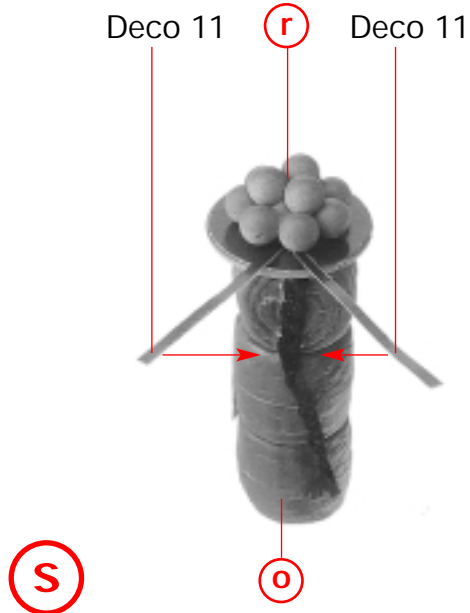
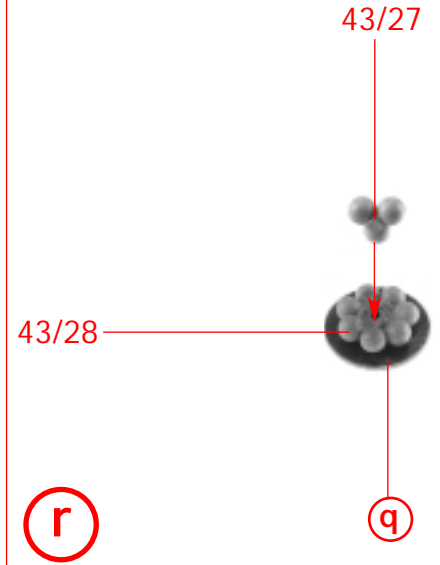
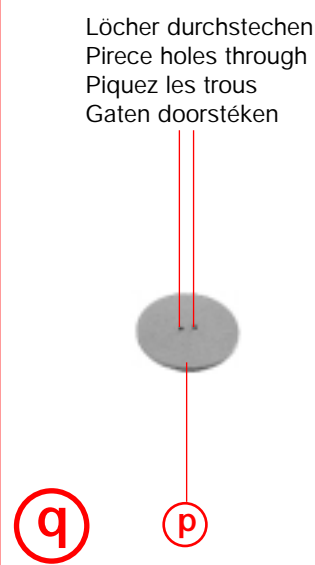
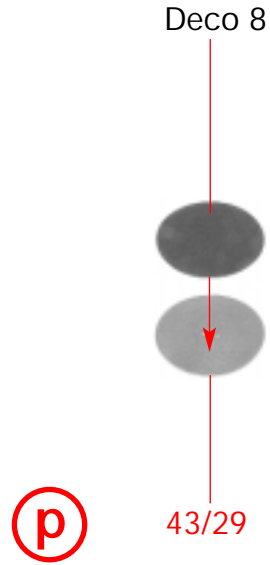
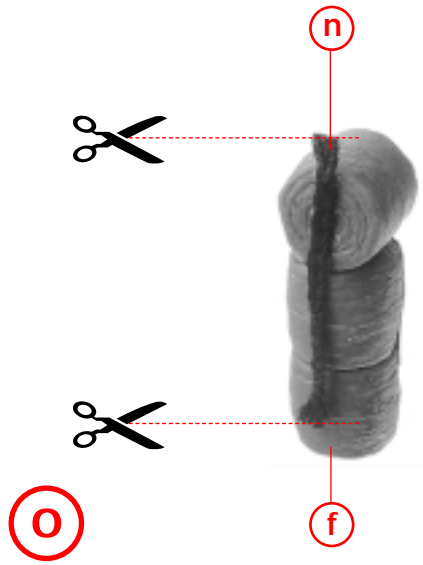

8

Deco 18

9/36

9/35



V

9/13

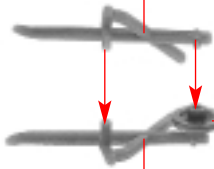

9/14

W

9/12

9/16

9/15



X

W

C

U

V

T

L

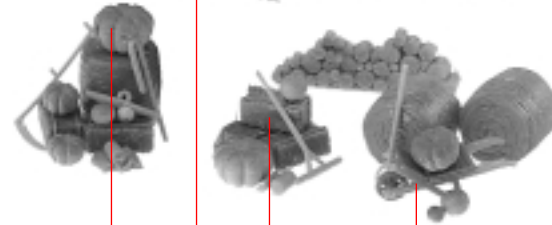
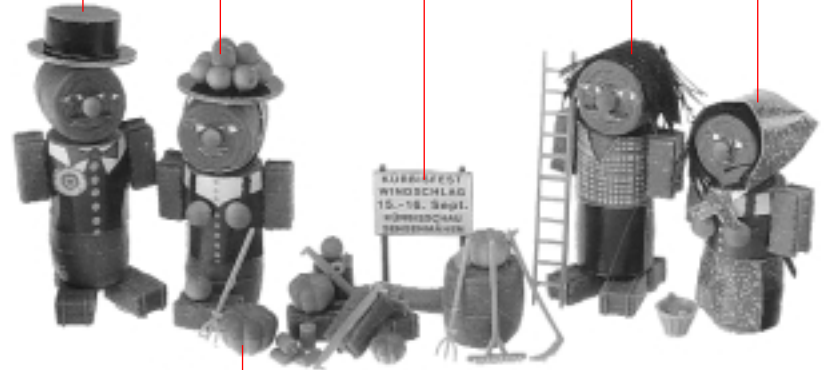

Ausschmückungsteile

Decoration parts

D'éléments décoratifs

Decoratiedelen

Y

X